

TRANSFER v2 ADD-ON™

ONE BIKE

ASSEMBLY

Parts



(2) M6 x 60 Flathead



(2) M6 Nut

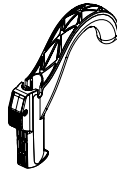

(1) Tire Hook



(1) Tire Hook Arm

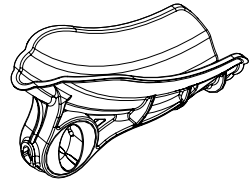

(1) Front Tire Cradle



(1) Locator Bolt



(2) Spacer

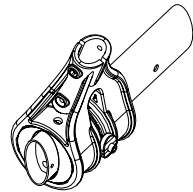

(1) Driver-Side Assembly



(2) M8 x 350



(2) M8 x 255

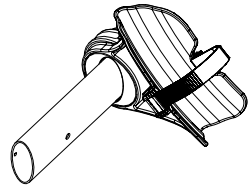

(1) Passenger-Side Assembly

Tools



2.5mm Allen Key



4mm Allen Key



Combo Hex Wrench



IMPORTANT

When loading a bicycle, ensure tire hook is placed as close to the bicycle fork as possible.

Placing the tire hook further away increases the risk of bicycle becoming unsecured in the rack, which may result in falling and damage.

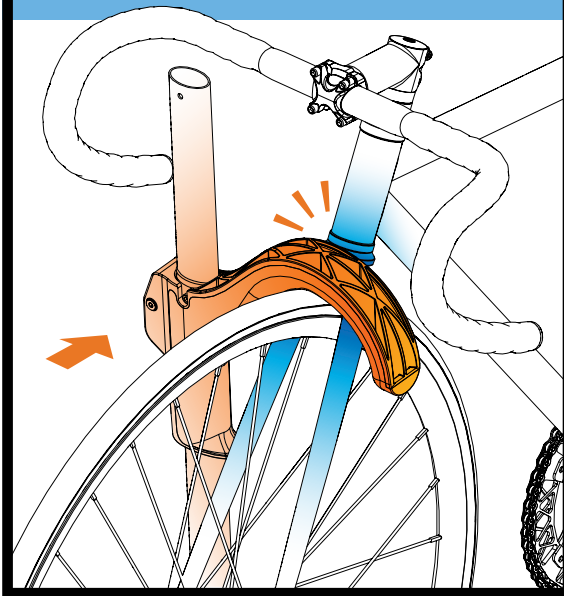

Driver-Side Assembly

- 1 Slide **Front Tire Cradle** into position.

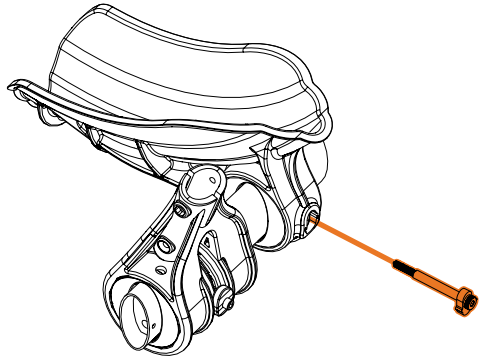
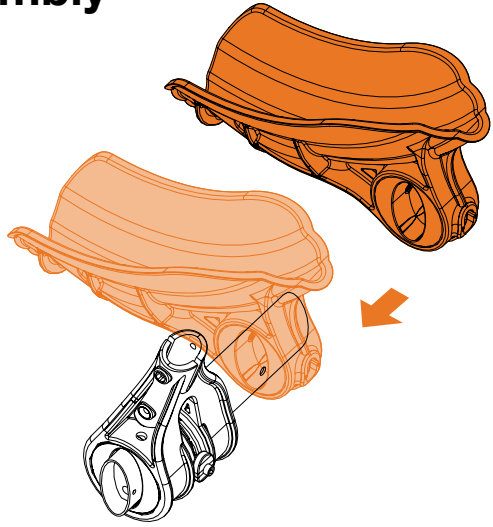

- 2 Install **Locator Bolt** in Position A as shown.

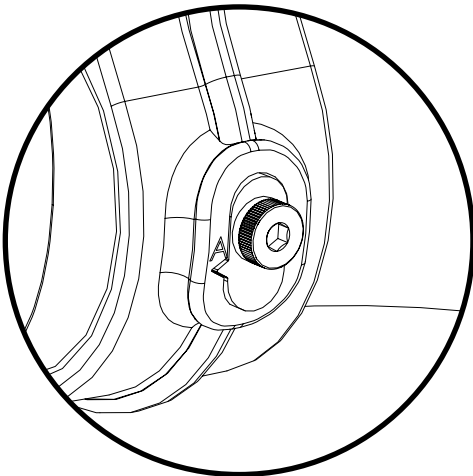

Tire Hook Arm Assembly

3 Push button on handle and slide **Tire Hook** up the **Tire Hook Arm** from the bottom.

4 Insert arm into **Arm Knuckle**.

5 Install (2) **M6 x 60 Flathead bolts** and (2) **M6 nuts**.

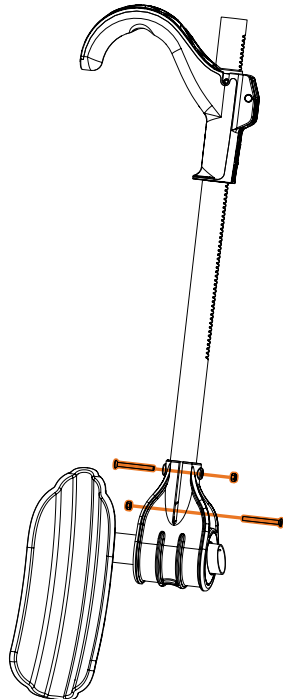
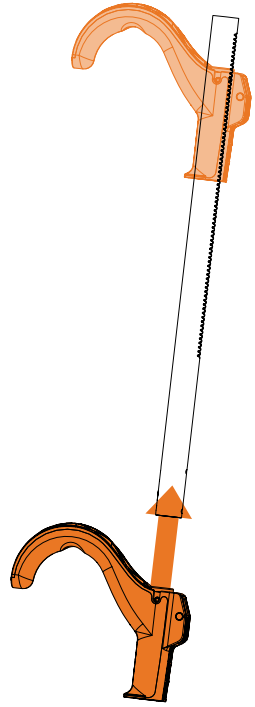

Endcap Removal

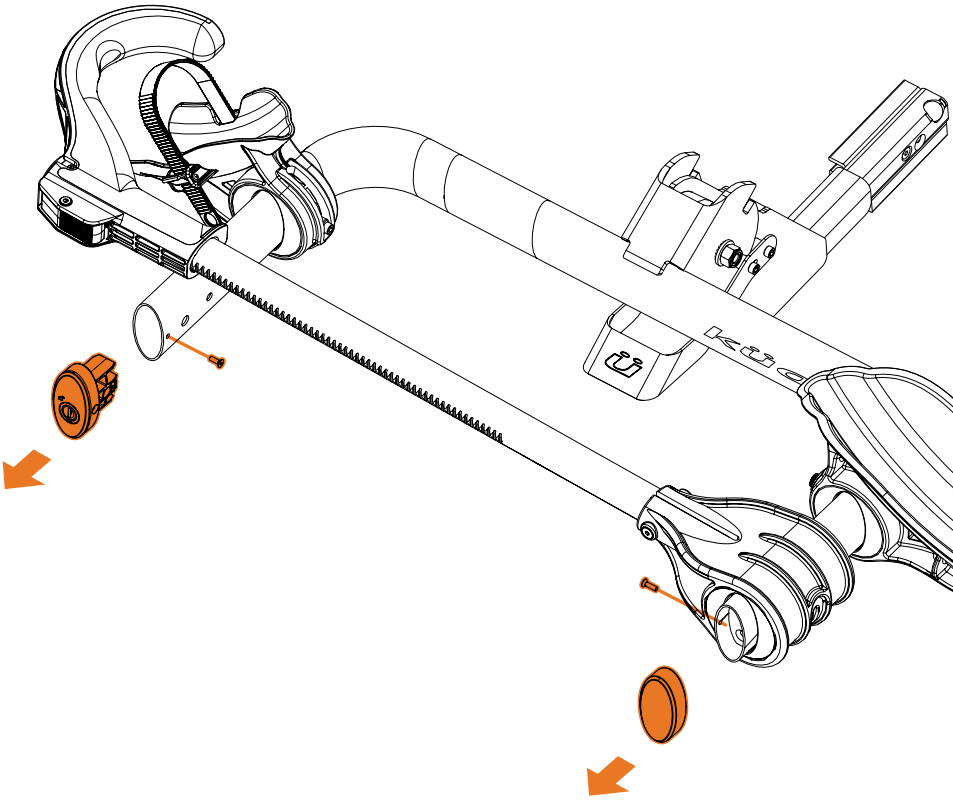

- 6 Remove (2) **M4 x 12 Flathead** bolts from driver-side and passenger-side **Endcaps**.

Remove **Endcaps** and set aside.

Driver-Side Assembly Installation

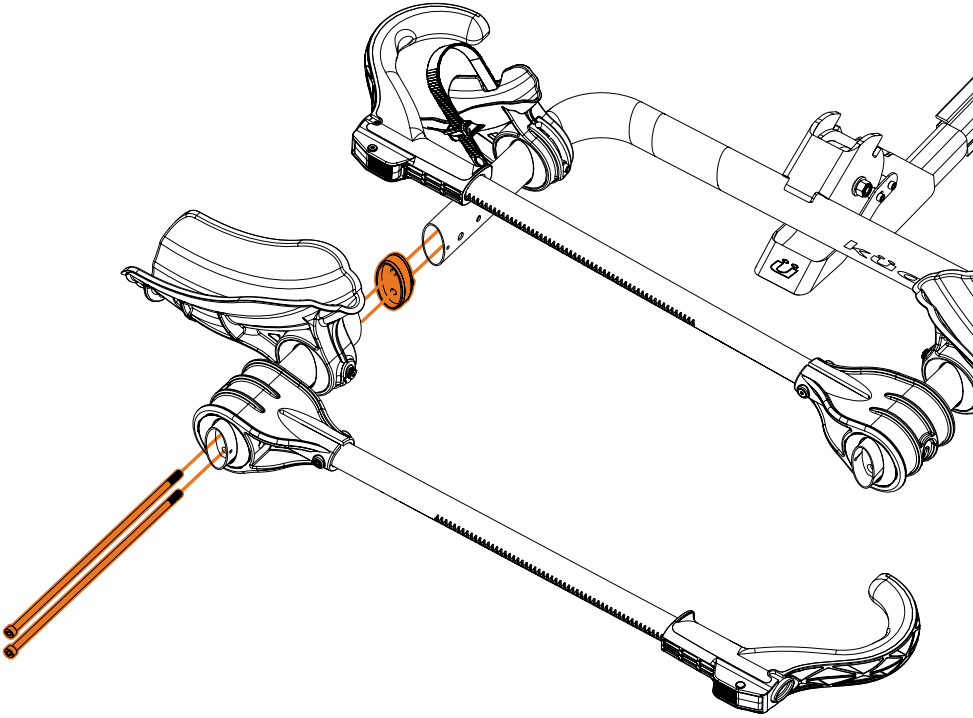

- 7 Attach Driver-Side Assembly to your rack using (2) **M8 x 350** bolts and **Spacer**.

Alternate tightening each bolt to ensure a secure, even fit.

Passenger-Side Assembly Installation

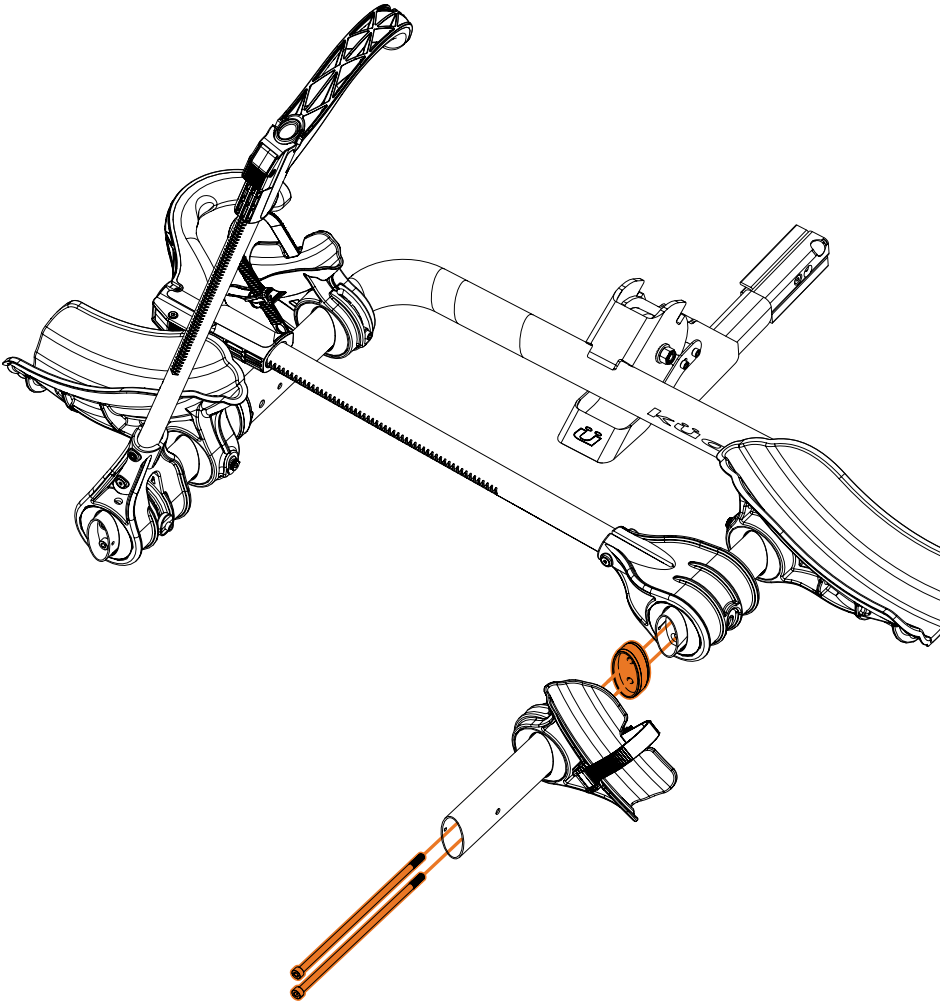

- 8 Attach Passenger-Side Assembly to your rack using (2) **M8 x 255** bolts and **Spacer**.

Alternate tightening each bolt to ensure a secure, even fit.

Reinstall Tray Endcaps

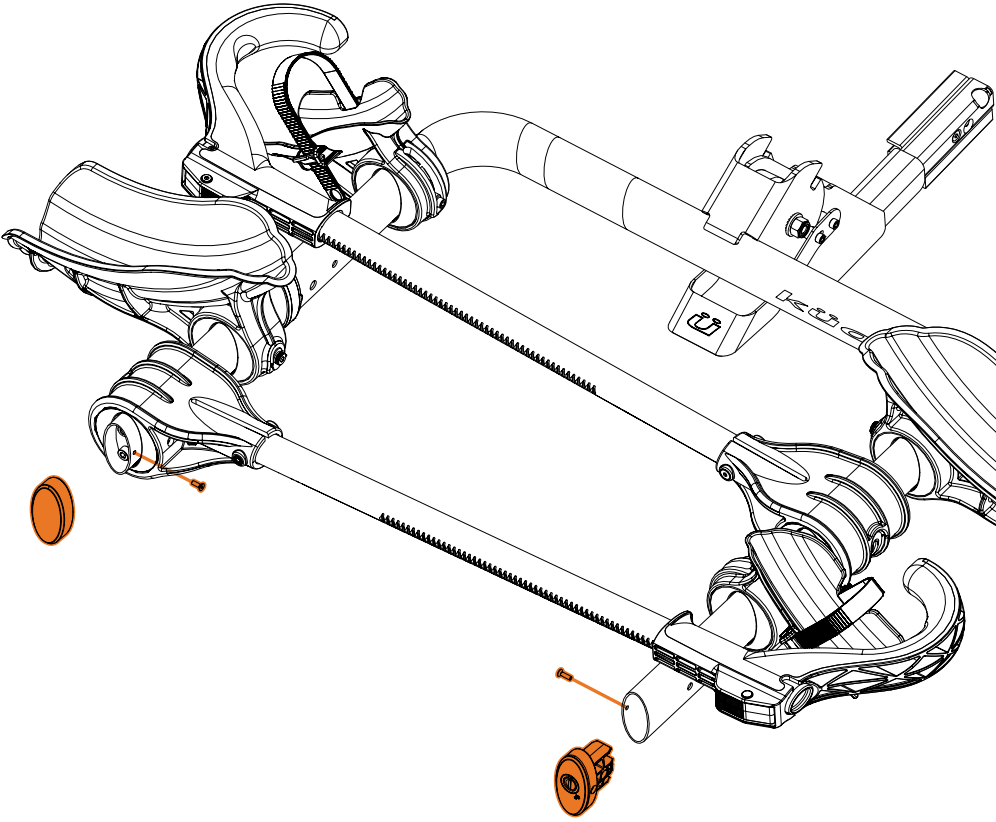

9 Reinstall Endcaps using the original (2) **M4 x 12 Flathead** bolts.

! Locking Side Endcap on the Passenger-Side, upside down.
Non-Locking Side Endcap now installs to the Driver-Side.

Küat Rack Warnings

ONE BIKE ADD-ON

TRANSFER v2

Number Of Bikes

+1

Weight Per Bike

40 lb

18.2kg

Max Wheelbase

50 in

1270 mm

Max Tire Width

5 in

127 mm

WARNINGS

- Follow instructions for proper assembly, installation and use.
- Check tightness of all bolts and screws periodically.
- Make sure rack and vehicle receiver are in working condition before each use.
- Only use Küat hitch extenders with this product.
- Place front tire ratchet arm as close to front fork as possible.
- Do not use front tire bicycle fenders with this product.
- Do not exceed the bicycle or weight limits intended for this rack.
- Rack weight capacity drops to 40lbs/bike when used with any Transfer V2 base rack.
- Do not use rack off road. (Rough, washed out, boulder-and-rut-strewn backroads)
 - Smooth gravel roads are not considered off-road.
- Do not use tarps, rain covers or wind covers with this product.
- Do not take through automatic car wash.
- Drive responsibly.

If you have questions or problems, please contact Küat Racks directly by calling toll free 1(877)822-KUAT, or by email: info@kuatracks.com

ADVERTENCIAS

- Siga las instrucciones para un montaje, instalación y uso adecuados.
- Compruebe periódicamente la estanqueidad de todos los pernos y tornillos.
- Asegúrese de que el estante y el receptor del vehículo estén funcionando antes de cada uso.
- Utilice únicamente extensores de enganche Küat con este producto.
- Coloque el brazo de trinquete del neumático delantero lo más cerca posible de la horquilla delantera.
- No utilice guardabarros delanteros para bicicletas con este producto.
- No exceda los límites de bicicleta o peso destinados a esta parrilla.
- No utilice el bastidor Off-Road *. (* Caminos en bruto, deslavados, llenos de rocas y surcos)
 - Los caminos de grava lisa no se consideran fuera de carretera.
- No use lonas, cubiertas para la lluvia o cubiertas para el viento con este producto.
- No realice el lavado automático de automóviles.
- Conduzca responsablemente.

AVERTISSEMENTS

- Suivez les instructions pour un assemblage, une installation et une utilisation appropriés.
- Vérifiez régulièrement le serrage de tous les boulons et vis.
- Assurez-vous que le support et le récepteur du véhicule sont en état de marche avant chaque utilisation.
- Utilisez uniquement des rallonges d'attelage Küat avec ce produit.
- Placer le bras de cliquet du pneu avant le plus près possible de la fourche avant.
- N'utilisez pas d'ailes de vélo avant avec ce produit.
- Ne dépassez pas les limites de vélo ou de poids prévues pour ce support.
- N'utilisez pas le rack Off-Road *. (* Routes rugueuses, délavées, parsemées de rochers et d'ornières)
 - Les routes de gravier lisses ne sont pas considérées comme hors route.
- N'utilisez pas de bâches, de housses de pluie ou de vent avec ce produit.
- Ne passez pas au lave-auto automatique.
- Conduisez de manière responsable.

Küat Racks Limited Lifetime Warranty

Küat honors the warranty on all Küat brand products for original owners of the product. Warranty is not transferable.

If a Küat rack that is covered by the terms of this warranty and is determined by Küat, to be defective, Küat will repair or replace the defective parts. Küat may choose in some cases to offer the owner a refund of up to the original purchase price of the product in lieu of repairing or replacing the product.

The Küat warranty does not cover any conditions that are beyond Küat's control. This includes, but is not limited to, the following: excessive loading, improper assembly, improper installation, theft, or any use that is not consistent with the user guide that is included with the product.

The Küat Warranty does not cover normal wear and tear, scratches, cosmetic oxidation, accidents, or damage due to unauthorized repairs or modifications.

If you are the original owner of a defective Küat product, please contact Küat at 1(877)822-5828. A Küat representative will work to quickly resolve the problem. If repairs are necessary, the owner will be responsible for the cost of returning the product to Küat for repair. No product should be returned to Küat without prior authorization from Küat staff.

LIMIT OF LIABILITY

THIS WARRANTY ONLY COVERS REPAIR, REPLACEMENT OR REFUND FOR THE COVERED KÜAT PRODUCT. ANY DAMAGE TO VEHICLE OR PROPERTY IS NOT COVERED BY THIS WARRANTY. PERSONAL INJURY IS NOT COVERED BY THIS WARRANTY.

LIMITATION OR EXCLUSION OF INCIDENTAL DAMAGE IS NOT ALLOWED IN ALL STATES SO THE ABOVE LIMITATIONS MAY NOT APPLY.

Küat respeta la garantía de todos los portabicicletas Küat mientras el comprador original sea el propietario de dicho producto. Si el comprador original vende o de alguna otra manera cede el producto a otra persona, la garantía será revocada.

Si un portabicicletas Küat que esté cubierto por los términos de esta garantía está defectuoso, Küat reparará o reemplazará las partes defectuosas a su propio criterio. Küat puede optar en algunos casos por ofrecer el reembolso del precio de compra del producto en lugar de repararlo o de reemplazar las piezas defectuosas.

La garantía Küat no cubre ninguna condición que esté más allá del control de Küat. Esto incluye, más no limita, carga excesiva, ensamblaje impropio, montaje impropio, robo o cualquier uso que no sea consistente con las instrucciones que están incluidas con el producto o que están disponibles para el usuario.

La garantía Küat no cubre el uso y desgaste natural, raspaduras, oxidación cosmética, accidentes, operación ilegal del vehículo o modificaciones o reparaciones no autorizadas.

Si usted es el propietario original de un producto Küat defectuoso, por favor contacte a Küat al 1(877) 822-5828. Un representante de Küat le atenderá para resolver su problema. Si son necesarias reparaciones, el propietario será responsable por el costo del envío del producto a Küat para su reparación. Ningún producto deberá ser enviado a Küat sin previa autorización de un agente de Küat.

LIMITE DE RESPONSABILIDAD

ESTA GARANTIA SOLO CUBRE REPARACIONES, REEMPLAZOS O REEMBOLSOS PARA EL PRODUCTO DE KÜAT CUBIERTO. CUALQUIER DAÑO AL VEHICULO O PROPIEDAD O LESION NO ESTA CUBIERTA POR ESTA GARANTIA.

LIMITANTES O EXCLUSIONES DE DAÑO ACCIDENTAL NO ESTAN PERMITIDAS EN TODOS LOS ESTADOS, POR LO TANTO ESTAS LIMITANTES PODRIAN NO APLICAR.

Küat honore la garantie de toute sa gamme du support de la marque Küat tant qu'il demeure la propriété du propriétaire original. La garantie prend fin lorsque le propriétaire original se départit du produit en le vendant ou en le transférant à une autre personne.

Si un article Küat fait défaut alors qu'il est sous garantie, Küat réparera ou remplacera, à sa discrétion, la ou les pièces défectueuses. Küat pourrait choisir dans certains cas d'offrir un remboursement du prix à l'achat au lieu de réparer ou de remplacer la pièce défectueuse.

La garantie Küat ne couvre pas les conditions hors du contrôle de Küat. Celles-ci incluent mais ne sont pas limitées à un chargement excessif, un assemblage erroné, un mauvais montage, le vol ou tout usage qui n'est pas conforme aux instructions (incluses avec le produit) accessibles à l'utilisateur.

La garantie Küat ne couvre pas l'usure normale, les égratignures, l'oxydation, les accidents, l'usage illégal d'un véhicule ou les réparations ou modifications non-autorisées.

Si vous êtes le propriétaire original d'un produit Küat défectueux, prière de contacter Küat au 1-877-822-5828. Un représentant Küat travaillera à la résolution du problème. Si des réparations sont nécessaires, l'acheteur doit assumer les frais d'envoi pour faire parvenir le produit Küat à l'entreprise. Ne retourner pas un produit Küat tant que vous n'obtenez pas l'autorisation d'un représentant de Küat.

LIMITE DE RESPONSABILITÉS

LA GARANTIE COUVRE SEULEMENT LA RÉPARATION, LE REMPLACEMENT OU LE REMBOURSEMENT D'UN PRODUIT KÜAT SOUS GARANTIE. LA GARANTIE NE COUVRE PAS LES DOMMAGES AU VÉHICULE, LES DOMMAGES À LA PROPRIÉTÉ NI LES BLESSURES.

LES RESTRICTIONS OU LES EXCLUSIONS CONCERNANT LES DOMMAGES ACCIDENTELLES NE SONT PAS ADMISES DANS TOUS LES ÉTATS OU CES RESTRICTIONS PEUVENT NE PAS S'APPLIQUER.

Küat RV Compatibility Warning

Küat's receiver hitch-mounted bicycle racks may be used with some recreational vehicles (RVs) as described below. Many types of RVs subject the rack and bicycles on it to high forces and extreme movements. As a result, Küat does not recommend using our receiver hitch-mounted products on RVs that will likely expose the rack to unacceptable conditions.

Küat's standard warranty will cover use of any of its 2-inch receiver hitch-mounted bicycle racks on motorhomes (as defined in 49 C.F.R. 571.3) satisfying all of the following requirements:

1. The receiver hitch is directly attached to the motorhome chassis, not just to the bumper;
2. The rear-most point of the receiver hitch where the bicycle rack will be attached is no more than 64 inches from the rear axle of the motorhome; and
3. The vehicle is a class B type motorhome as described below.

Class B type motorhomes are commonly known as van conversions and comprise a completed van-type vehicle which has been altered to provide temporary living quarters. Class B type motorhomes have a gross vehicle weight rating of 10,000 lbs or less.

In addition, the 2 inch receiver Transfer™ v2 and the 2-inch receiver Piston Pro X may be used on RVs (both motorhomes and trailers) satisfying all of the following requirements:

1. The receiver hitch is directly attached to the RV chassis, not just to the bumper; and
2. The bicycle rack is in the 2-bike configuration with no add-on unit attached.

Please check the Warnings section of the User Guide for load weight limits applicable to your rack when used on an RV. Lower weight limits apply.

Even if the conditions above are met, any RV may be operated in a way that will expose Küat's products to conditions that they are not designed to handle. The operator of the RV is responsible to operate the RV in a manner that will not overload the rack, such as by excessive speed over rough roads or speed bumps, rapid turning movements, driving the RV over changes in gradient that will bring the rack in contact with the ground, or other similar actions.

kuat[®]

1.877.822.5828

info@kuat.com

kuat.com

v.02